



Eastern

ARCHITECTURAL SYSTEMS

**ALUMINUM AND VINYL
IMPACT WINDOWS AND DOORS**



Your View Is Our Focus.

quality, reliability, integrity

www.easternarchitectural.com

About Us



Eastern Metal Supply acquired Flesher Windows in early 2011, rebranding the entity as Eastern Architectural Systems (EAS). EAS is now led by executives experienced in instilling our corporate values of service and quality, key to our growth since 1982.

By leveraging the quality of the former Flesher product line with our company culture of integrity and reliable after-sale service, our dealers exceed their customer's needs with assurance unmatched by any other manufacturer.



EAS manufactures a complete line of custom-made windows & doors in both aluminum and vinyl at our facility in Ft. Myers, FL. In addition to regular windows, we offer the highest quality of impact resistance and energy efficiency!

Whether impact glass or insulated impact glass, we have a style that will meet the needs of your customer. EAS is the only Company in Florida that offers a vinyl impact window with the Good Housekeeping Seal of Approval.



EAS FACILITY IN FORT MYERS, FL

As part of the Earthwise Group, EAS also became the first window manufacturer to earn "Made in USA Certified®." This is the nation's leading independent certification source. To earn the certification, the Earthwise Group went through a rigorous supply chain audit to ensure that at least 99.9% of the organization's products and processes originate and are completed in the United States. Products produced by the Earthwise Group members consistently meet and exceed the rigorous standards set by Energy Star, the National Fenestration Rating Council (NFRC), and the American Architectural Manufacturers Association (AAMA).

Eastern Architectural Systems and its' parent company, Eastern Metal Supply, now have 9 locations throughout the U.S.A. Our resources and manpower allow us to bring the best products to the marketplace with quality, price and service as our priority.



*quality,
reliability,
integrity*

THAT'S WHO WE ARE.

*Let us make a difference
for you now!*



Eastern Architectural Systems (EAS) wants to be your sole resource for all of your window, door, and storm protection needs. We have all of the products necessary to provide the solutions you need and to exceed your customers' expectations. We now have over 60 product approvals with many more to come!

Everything we make at EAS is custom made by craftsmen that use only the best aluminum alloys, the highest quality plastics, and glass from the most well-known suppliers in the industry. We take great pride in offering what we think is the ultimate in window products.

Our product line is continually growing as we look to provide new products as an industry leader. Our progressive approach allows us to focus on state-of-the-art machinery and processes. The Eastern Architectural work force is highly skilled and is given direction by a rigorous quality control program that ensures nothing but the best for our customers.

We have the ability and resources to tackle the large commercial and condominium projects, while still being able to focus on residential new construction and retrofits. No job is too small or too large.

You should see our customer service! It goes beyond just having great products. We strive to get our products out with short lead times and manufactured with accuracy. Our leading-edge technology allows us to produce our windows & doors with amazing accuracy. Your orders are now computerized with our "Fenevision" online order system. Our fleet of trucks are always in your area making on-time deliveries with complete orders.

Our products are available through our independent distributors and comprehensive dealer network. From ordering through delivery, EAS is ready to meet the challenge and exceed your expectations. We have the best sales representatives and tech experts that can assist you with any project. Call now to see how we can make a difference for you (1-800-686-8902)!



HURRICANE ANDREW
24 AUGUST 1992
3 AM EDT 926 MB

*Built to take on the
worst that Mother
Nature can offer.
- Hurricanes too!*

HURRICANES?

*No problem, we have been in the storm & security
business since 1982.*

From Hurricane Andrew in 1992 to Floyd in 1999. Ivan, Jeanne, Frances, Charley in "04" and Katrina, Rita, and Wilma in "05", we have seen it all. We will certainly see more of this activity in the future. Hurricane protection is no longer considered a luxury, it is a necessity! With Bertha™ Impact Windows & Doors, you have the protection you need to properly deal with the forces of nature.

It is now well known that flying debris will break normal windows, which can cause a sudden internal pressurization within your home. This is a common cause for most roof failures. By having impact-resistant glass, you significantly improve the home's structural integrity and can avoid any potential "breach of the home's envelope." Our systems provide maximized resistance and certified protection.

Bertha™ impact resistant windows and doors not only meet all local building codes, they can also provide an energy efficient alternative and a great solution for security 24/7. Our heavy duty aluminum or vinyl frames combined with laminated glass, can absorb the impact from flying debris without penetrating the durable interlayer. There is NO advance preparation required with our impact windows and doors.

Once installed, you will have an investment that pays for itself and the "peace of mind" that you deserve. **Bertha™ Impact Windows & Doors**, the right product for you!





Bertha™ Impact Windows & Doors are designed to provide the ultimate in strength while giving homeowners aesthetic quality and energy efficiency, all at the same time.

Our impact windows are ready to not only protect you against the elements, but they also dramatically reduce outdoor noise. Your home is your castle, so why not make it like a fortress without having to sacrifice any beauty? Now you can filter out over 90% of the sun's UV rays to help protect against any fading on furniture, carpet, drapes and even artwork!

Our products meet Florida's toughest building codes and have product approvals / certifications from the most well known agencies. Tested in independent laboratories for wind, water, structural, and impact – large missile. Our products are approved by the State of Florida for use anywhere, including the High Velocity Hurricane Zone! Next time it appears as if another storm is heading your way, you can relax and remain confident knowing your work is already done. When it comes to protecting your home and family, don't settle for just any window, get **Bertha™ Impact Windows & Doors.**

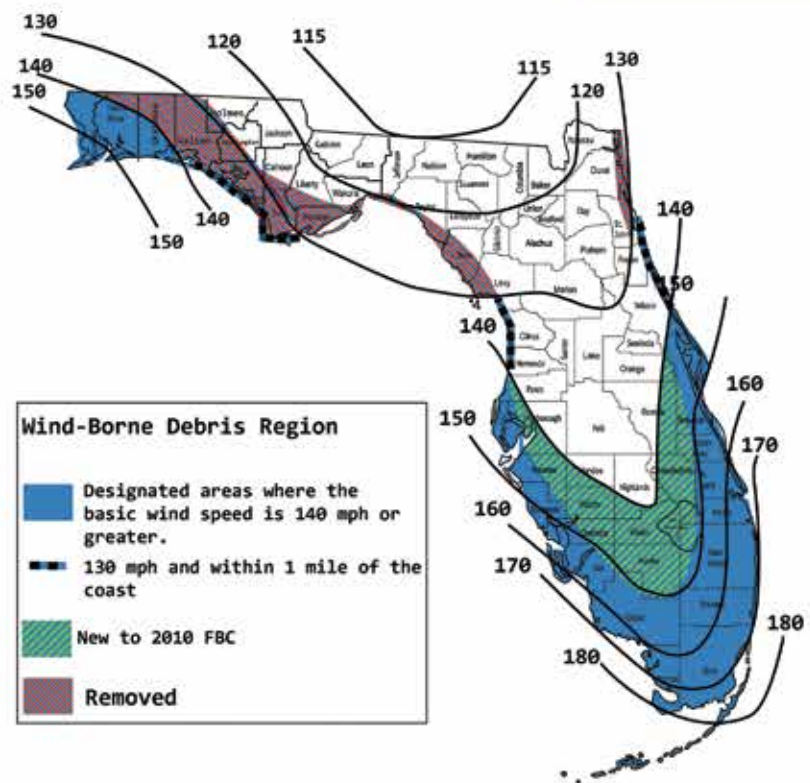

Figure 1609A Wind-Borne Debris Region, Category II and III Buildings and Structures except health care facilities

General Specifications

COMPANY SUMMARY

EAS is headquartered in Ft. Myers and is one of 9 locations that Eastern Metal Supply has throughout the USA.

We recently broke ground for a new 172,000 square foot facility that is designed to have an 80,000 square foot addition to accommodate future growth. With our ever growing product line and increased demand, EAS has put itself in position to significantly increase its market share and become a major force regionally and nationwide.



MATERIALS & CONSTRUCTION

- Durable Aluminum Alloy 6063 – T6
- Fusion Welded Frame & Sash
- Heavy Walled Construction
- Unique Cove Molding
- Multi-Chambered Frames
- Wide Variety of Frame Colors
- Optional Stainless Steel Components
- Full Assortment of Grid & Muntin Options
- Double Veined Felts
- Heavy Duty Locks & Rollers
- High Mil Rubber Weather Stripping
- 5 Degree Sloped Sill
- Multi –Point Locks
- Deeply Pocketed Head
- Concealed Fasteners
- High Quality Vinyl-Lifetime Warranty



TESTING STANDARDS

EAS Windows & Doors are tested to the most stringent standards in the Industry:

TAS 201, 202, 203 – High Velocity Hurricane Zone

ASTM, E1886-1996

AAMA/WDMA/CSA 101/I.S/A440

NFRC - and the list goes on!

Choosing the Right Glass Package

Just want to upgrade your windows and doors to something more contemporary? Regular non-impact windows may be a viable alternative for a low budget.

This would typically consist of regular annealed glass for the windows and tempered glass for sliding glass doors. Our non-impact windows are available with insulated glass.

Annealed Glass can be used for most applications provided they meet windload, thermal stress and building code requirements of the project.

Heat Strengthened glass is approximately two times as strong as annealed glass in resisting windloads. If it meets all requirements, codes and specifications, heat strengthened glass should be used in all applications where annealed glass will not meet thermal or windload requirements.

Tempered Glass is approximately four times as strong as annealed glass in resisting windload.

Impact Glass is produced by laminating 2 sheets of glass to an interlayer in the middle.

Low E Glass (low emissivity) is a special clear coating that helps block UV rays while optimizing light transmission.

Glass Tints provide another effective way at reducing solar heat gain by reducing the amount of heat transmitted through your windows.

Impact Insulated Glass provides an additional layer of glass that results in an insulation barrier between the inside and outside of your home.

Argon Gas is an option for impact/insulated glass which helps reflect outside heat and regulate the temperatures inside your home.



Solar heat gain is the amount of heat producing radiation that is transmitted through the glass. Visible light transmission is the amount of daylight that is admitted through the glass.



The Fifth Edition FL Energy Code expand the counties included in Zone 1. Ensure you know which products are in compliance in your area. An energy value product matrix can be found on www.easternarchitectural.com, under the Knowledge Center.

LOW-E GLASS

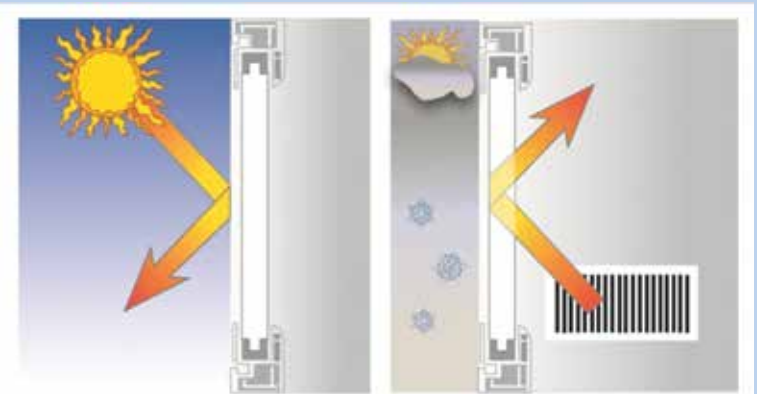

During the summer, the Low-E helps reflect the heat energy from the sun away from your home for cooler inside temperatures.

During the winter, this glass allows for natural light to come in, but keeps heat energy inside your home for warmer inside temperatures.

THIS HELPS PROVIDE BETTER INSULATION AND MORE ENERGY SAVINGS ALL YEAR.

Impact Glass Explained

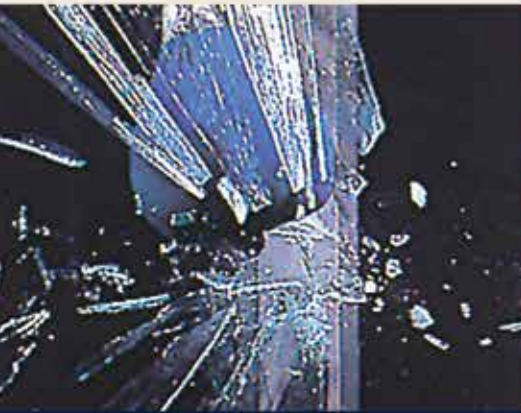

ANNEALED GLASS BREAKS EASILY, PRODUCING LONG, SHARP SPLINTERS.



LAMINATED GLASS MAY CRACK UNDER PRESSURE, BUT TENDS TO REMAIN INTEGRAL, ADHERING TO THE VINYL INTERLAYER



9 LB 2X4 MISSILE SHOT AT 50 FT/SEC TESTS IMPACT WINDOW

Impact Glass, also known as Laminated Glass, is typically found as two pieces of glass with an interlayer made of a durable vinyl (PVB/SGP).

This innovation is not that new, as a similar product has been around for many years in the automotive industry – windshields.

A typical piece of impact glass consists of three layers that are fused together through a laminating process, which involves pressure and heat. The process results in providing a stronger and sturdier glass unit. The exterior glass pieces can be regular glass or heat strengthened glass, depending on the strength requirement. Also, there are different thicknesses of glass that can be used depending on what is needed for design pressures and code compliance.

There are varying types of interlayers as well, that can help determine the outcome of strength. Larger window units or units

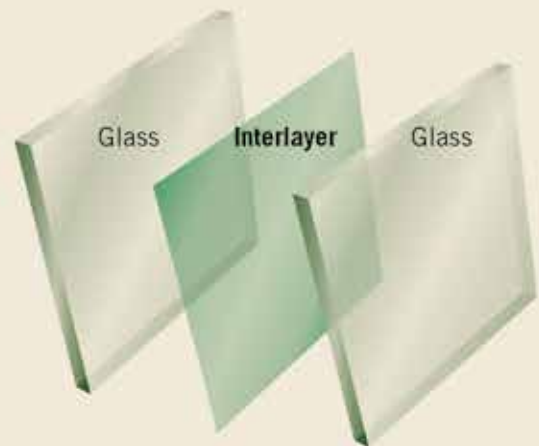

to be used in hurricane-prone coastal areas may need thicker/stronger combinations in order to meet the local requirement for building codes.

Eastern Architectural Systems uses only the best laminated glass from suppliers like Cardinal Glass, to ensure quality and to maximize strength.

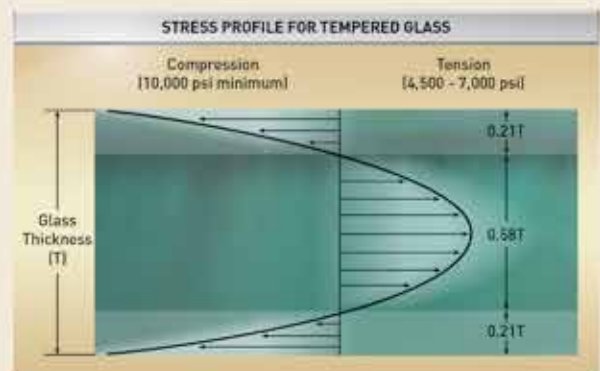
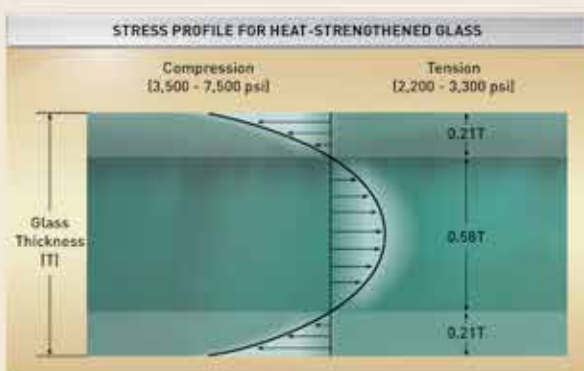

Aluminum Impact Windows



Hurricane

Security

Noise Reduction

UV Protection

Energy Efficiency

So many solutions derived from just one window! The aluminum style is very popular in the Southeast USA, especially in Florida where strength and durability are sought after features. For many years, this has been the standard choice for discerning homeowners looking for impact resistant window systems.

The impact resistant glass is comprised of two panes of glass bonded together with a special interlayer of clear PVB. This combination of glass along with the heavy duty frames provides first class protection from hurricane force winds and flying debris. You can rest assured that wind, water, and uninvited guests stay out of your home.

These systems are available with insulated glass too for those looking for the optimum in energy efficient solutions! The aluminum windows are available in white or bronze frames with a variety of tint options so you can easily coordinate with your aesthetic and sun control needs.

From hurricane protection to security, this system is a smart way to protect your family! **Bertha™ Impact Windows & Doors** combines the best of beauty, strength and value.

FEATURING:

- Heavy duty aluminum frames
- 6063 T-6 aluminum alloy
- Impact resistant laminated glass
- Mechanically fastened corners
- Corrosion resistant hardware with stainless steel options
- Insulated glass as an option with some styles

TESTED FOR:

- Large missile impact
- Water resistance
- Air infiltration
- Forced entry
- Structural integrity

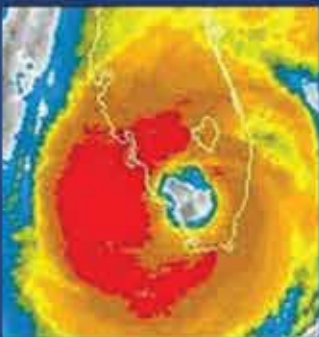

Vinyl Windows, A Great Choice!



Enjoy the benefits of energy efficient vinyl windows and doors that are available in a variety of styles and fit most applications.

All vinyl windows from **Bertha™ Impact Windows and Doors** are insulated. Not only do you save money on your electric bill, you get a lifetime warranty on the vinyl frames.

The multi-cavity chambers help to insulate the air and to reduce the transfer of heat into your home. These multiple walls add to the strength and rigidity of the product as well. EAS uses only the highest grade resins and additives to achieve optimal weathering, durability, color retention, and impact resistance. Purchase these money savers with confidence.

Vinyl windows are very durable and resist corrosion, rotting, chipping and peeling. These are very easily cleaned and are not susceptible to insect or fungus attack. Also, the vinyl windows are in an elite class as they are "Made in the USA" Certified. And there is more - Eastern Architectural Systems and its **Bertha™ Impact Windows & Doors** are part of the exclusive Earthwise Group, which also has the Good Housekeeping Seal of Approval.

- Fusion Welded 3 ¼" Frame & Sash
- Unique Cove Mold Design
- 5 Degree Sloped Sill
- Heavy Walled Construction
- Deeply Pocketed Head
- Insulated Glass
- Lifetime Warranty on Glass & Frame
- Made in the USA Certified

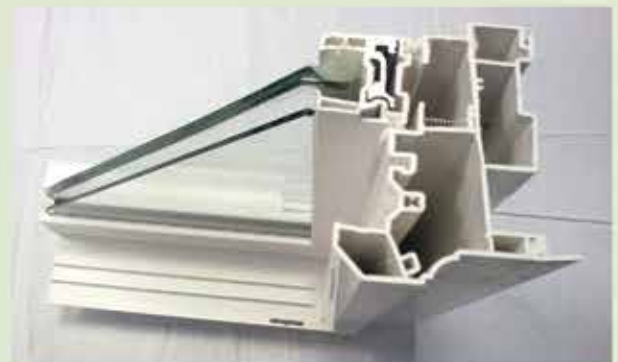

Energy Efficiency = WINDOW\$ that PAY!

Bertha™ Impact Windows & Doors are available in different configurations so you can address energy efficiency in a multitude of ways.

Whether your windows are aluminum or vinyl, there are many options available to minimize your energy consumption!

Most customers prefer to have some sort of glass tint, which is a great start. This is a very effective way to reduce energy costs. Tinted glass absorbs solar radiation as it enters through the glass, thereby reducing heat and light transfer into the room.

Consider going to the next step by getting a Low E glass coating. Low E coatings are applied to the internal glass to separate both heat and light energy.

The heat is reflected back to the heat source and the short wave light can pass through the coating to allow for interior illumination.

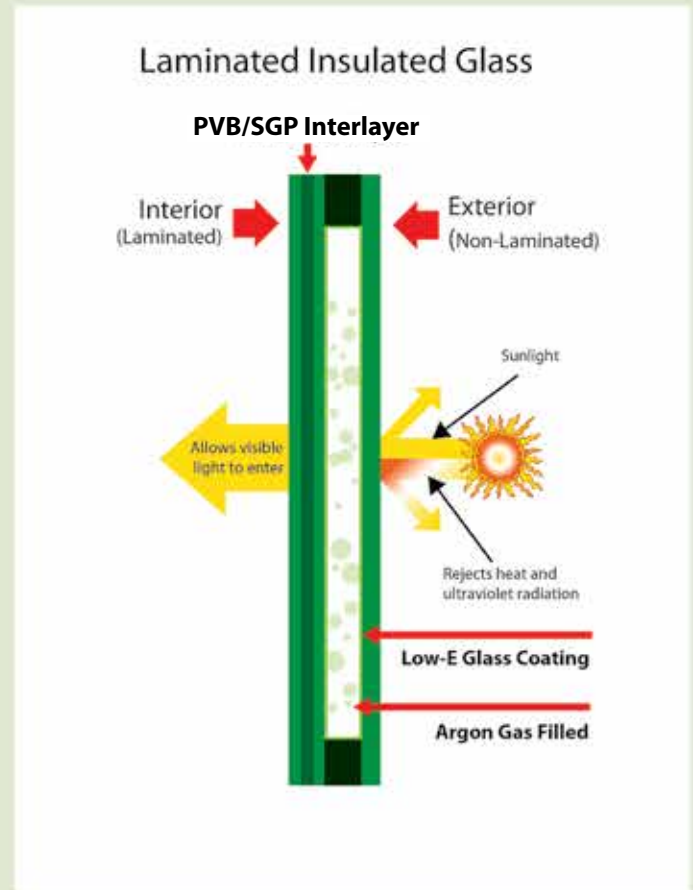

Many customers are now maximizing their energy efficiency by incorporating an extra pane of glass as found in our insulated glass systems. This will give you an extra layer of insulation between your impact glass and the outdoor exterior. If you fill this space with argon gas, you will have reached the maximum potential for energy efficiency and may qualify for an Energy Star rating! Allow normal light transmission into your home without the harmful UV radiation.



The highest grade material available, coupled with an effective design, gives you the most technologically advanced product in today's market.

With **Bertha™ Impact Windows & Doors**, you will get the best value from our high quality products that can actually help you save money on a daily basis!

SINGLE HUNG - Aluminum & Vinyl

Impact & Impact Insulated • Approved for the HVHZ!



ALUMINUM

MAXIMUM SIZE	GLAZING	NOMINAL GLASS	DESIGN PRESSURE
53 1/8" x 96"	Impact	5/16" annealed	+/- 60
53 1/8" x 72"	Impact	7/16" Heat Strength	+60/-80
53" x 77"	Impact	7/16" Heat Strength	+80/-100
53 1/2" x 77"	Impact	1/2" Heat Strength	+120/-150
48" x 72"	Insulated Impact	3/4" IGU – 5/16" HS	+/- 75
53 1/8" x 78"	Insulated Impact	7/8" IGU – 7/16" HS	+80/-100
Muntin			Flat, Profile, OG

VINYL

MAXIMUM SIZE:	Flange - 53 1/8" x 72"
MAXIMUM SIZE:	Fin - 48" x 72"
DESIGN PRESSURE:	+/- 50 PSF

VINYL - HVHZ

MAXIMUM SIZE:	Fin - 53 1/8" x 77"
MAXIMUM SIZE:	Flange - 53 1/8" x 77"
DESIGN PRESSURE:	+70/-85 PSF

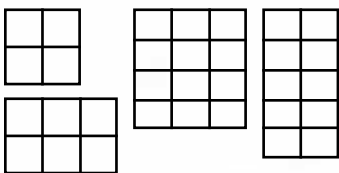

We have all of the standard & custom configurations for sizes and grid patterns - A wide variety of standard colors to choose from!

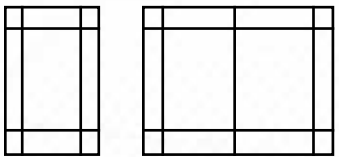

Eastern Architectural Systems carries a full line of DOUBLE HUNG windows too!

See more at www.easternarchitectural.com

FEATURES & BENEFITS

VINYL

- **Fusion Welded 3 1/4" Frame & Sash** provides an impenetrable barrier to air & water penetration and the utmost in strength, stability, and rigidity.
- **Unique Cove Mold Design** offers a more traditional wood window exterior appearance.
- **5 Degree Sloped Sill** provides improved water runoff, even in driving rain.
- **Deeply Pocketed Head** with weather stripping to resist air infiltration.
- **Heavy Walled Construction** .070" walls are a full 12% thicker than most other windows and provide a better thermal barrier.
- **Coil Pak Balancers** provide a smooth and maintenance free sash operation.
- **Attractive Integral Lift Rail** provides easy sash operation.
- **Tilt Sash** for easy cleaning.
- **Lifetime Warranty** on all vinyl frames.
- **Made in the USA** Certified.

ALUMINUM

- **Frame Depth** of 3 1/4" provides superior strength and durability.
- **Double Veined Felts** used to maximize prevention of air and water penetration.
- **Uniform Construction** for all applications. Ensures windows with different DP will look the same throughout a building.
- **Stainless Steel Components** available for longer life and protection against corrosion.
- **Preloaded Spring Balancers** for ease of operation and longer life.
- **Will accommodate virtually any glass** option available, to help make your building unique.
- **Insulated glass** available for greater energy efficiency.

CASEMENT - Vinyl

Impact & Impact Insulated • Approved for the HVHZ!



VINYL

Maximum Size	37" x 75"
Design Pressure	± 50 PSF
Glass	Available in Insulated & Insulated Impact
Muntin	GBG & SDL
Grid Options	Colonial, Prairie, Perimeter
Frame Depth	3 1/4"
Colors	White, Desert Sand, & Bronze Ext/White Int
HVHZ Approval	No

VINYL - HVHZ

Maximum Size	37" x 76"
Design Pressure	± 70 PSF
Glass	Insulated Impact 3/4" IGU- 5/16" Ann
Muntin	GBG & SDL
Grid Options	Colonial, Prairie, Perimeter
Frame Depth	3 1/4"
Colors	White, Desert Sand, & Bronze Ext/White Int
HVHZ Approval	Yes

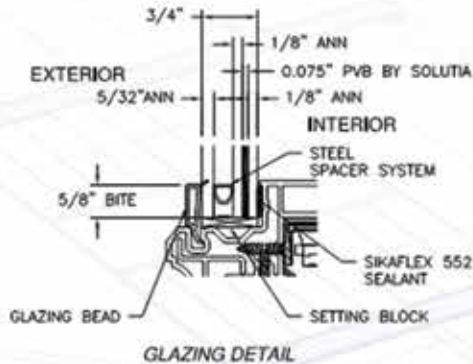

Lock Bar & Handle



Egress & Washable Hinges

FEATURES & BENEFITS

- **Fusion Welded 3 1/4" Frame & Sash** provides an impenetrable barrier to air & water penetration and the utmost in strength, stability, and rigidity.
- **Unique Cove Mold Design** offers a more traditional wood window exterior appearance.
- **5 Degree Sloped Sill** provides improved water runoff, even in driving rain.
- **Deeply Pocketed Head** with weather stripping to resist air infiltration.
- **Heavy Walled Construction** .070 walls are a full 12% thicker than most other windows and provide a better thermal barrier.
- **Coil Pak Balancers** provide a smooth and maintenance free sash operation.
- **Attractive Intergral Lift Rail** provides easy sash operation.
- **Tilt Sash** for easy cleaning.
- **Lifetime Warranty** on frames and glass.
- **Made in the USA Certified.**

HORIZONTAL ROLLER - Aluminum & Vinyl

Impact & Impact Insulated • Approved for the HVHZ!



ALUMINUM

Maximum Size	XO - 74" x 63"
Maximum Size	XOX - 120" x 63"
Design Pressure	± 80 up to +100/-120
Glass Thickness	7/16 HS, 1/2 HS
Muntin	Flat, Profile, OG
Grid Options	Colonial, Prairie, Perimeter, Other
Frame Depth	3 1/4"
Frame Colors	White & Bronze
HVHZ Approval	Yes

VINYL

MAXIMUM SIZE:	72" x 60"
DESIGN PRESSURE:	± 50 PSF
GLASS:	Available in Insulated & Insulated Impact

VINYL - HVHZ

MAXIMUM SIZE	GLAZING	FRAME	DESIGN PRESSURE
111" x 63" xox	Impact	1/3-1/3-1/3 Fin	+60/-70
		1/3-1/3-1/3 Flange	+65/-85
111" x 63" xox	Impact	1/4-1/2-1/4 Fin	+50/-55
		1/4-1/2-1/4 Flange	+50/-65
74" x 63" xo	Insulated Impact	Fin / Flange	+70/-85

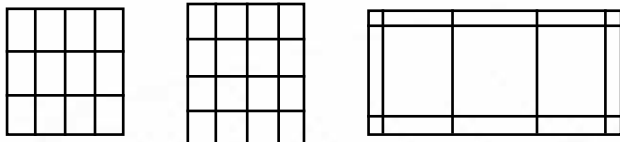

2 or 3 Lite configurations with Picture Window included (HRP)



UNEQUAL LITE

EQUAL LITE

FEATURES & BENEFITS

VINYL

- **Fusion Welded 3 1/4" Frame & Sash** provides an impenetrable barrier to air & water penetration and the utmost in strength, stability, and rigidity.
- **Unique Cove Mold Design** offers a more traditional wood window exterior appearance.
- **Deeply Pocketed Head** with weather stripping to resist air infiltration.
- **Heavy Walled Construction** .070" walls are a full 12% thicker than most other windows and provide a better thermal barrier.
- **No Sill Screws** penetrate the sill for enhanced leak protection.
- **Lifetime Warranty** on all vinyl frames.
- **Made in the USA** Certified.

ALUMINUM

- **Frame Depth** of 3 1/4" provides superior strength and durability.
- **Double Veined Felts** used to maximize prevention of air and water penetration.
- **Uniform Construction** for all applications. Ensures windows with different DP will look the same throughout a building.
- **Stainless Steel Components** available for longer life and protection against corrosion.
- **Heavy Duty Adjustable Rollers** for ease-of-operation, install, and longer life.
- **Removable Operating Sash** for easy cleaning.

PICTURE WINDOW - Aluminum & Vinyl

Architectural • Impact & Impact Insulated • Approved for the HVHZ!



VINYL Non-HVHZ

MAXIMUM SIZE:	Non-Impact	75" x 72"
MAXIMUM SIZE:	Impact	64" x 84"
DESIGN PRESSURE:	± 50 PSF	

GLASS: Available in Insulated & Insulated Impact

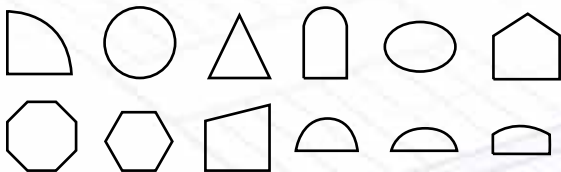

Wide Range of Architectural Shapes Available

FEATURES & BENEFITS

VINYL

- **Fusion Welded 3 1/4" Frame & Sash** provides an impenetrable barrier to air & water penetration and the utmost in strength, stability, and rigidity.
- **Unique Cove Mold Design** offers a more traditional wood window exterior appearance.
- **Heavy Walled Construction** .070" walls are a full 12% thicker than most other windows and provide a better thermal barrier.
- **Great option** for most applications.
- **Lifetime Warranty** on all vinyl frames.
- **Made in the USA** Certified.

ALUMINUM 3000 SERIES

MAXIMUM SIZE	FRAME	DESIGN PRESSURE
48" x 120"	Flange PVB	Insulated Impact +70/-70
48" x 54"	Flange PVB	Insulated Only +85/-90
Optional SGP Interlayer		Insulated Impact (min) +95/-100
		Impact Only +/- 100
Glass Thickness		7/16" or 1 1/32"
Muntin		GBG & SDL
Grid Options		Colonial, Prairie, Perimeter
Frame Depth		3 1/4"
Frame Style		Fin & Flange
Colors		White & Bronze
Option		Insulated Glass
HVHZ Approval		Yes

VINYL - HVHZ

MAXIMUM SIZE	FRAME	DESIGN PRESSURE
72" x 84"	Fin	+80/-80
72" x 63"	Flange	+80/-80
	Frame	+80/-80
Muntin		GBG & SDL
Grid Options		Colonial, Prairie, Perimeter
Frame Depth		3 1/4"
Frame Style		Fin & Flange, Box
Colors		White, Desert Sand & Bronze Ext/White Int
Insulated Glass		1" Glass Pack
HVHZ Approval		Yes

ALUMINUM

- **Heavy Duty** Aluminum Alloy featuring 6063-T6.
- **Uniform Construction** for all applications. Ensures windows with different DPs maintain the same external look throughout the building.
- **Heat Strengthened Glass** is an integral part of all types for this product.
- **Large Sizes Available** to cover most applications. Tested and approved for XL openings.
- **Concealed Fasteners** for a finished look.
- **Allows for Multi-Configurations** where you can mix & match with other styles for aesthetic quality.
- **Insulated Glass Option** is available to help with your energy efficiency optimization plan.

SLIDING GLASS DOOR - Aluminum & Vinyl

Impact & Impact Insulated • Approved for the HVHZ!



623 VINYL

Maximum Size	192" x 96"
Large Missile Impact Level	Level D, Windzone 4
AAMA/WDMA/CSA	101A.S.2/A440
ASTM	E1886-05 ASTM E1996-05
Muntin	Flat
Grid Options	Colonial, Prairie, Perimeter
Product Rating	SD-C50
HVHZ Approval	No
Frame Colors	White, Brz/Wht & Desert Sand
Configurations	OX OR XO, OXO, OXXO

623 VINYL - HVHZ

Maximum Size	192" x 96"
Design Pressure	±65
Large Missile Impact Level	Level D, Windzone 4
AAMA/WDMA/CSA	101A.S.2/A440
ASTM	E1886-05 ASTM E1996-05
Muntin	SDL, Flat
Grid Options	Colonial, Prairie, Perimeter
HVHZ Approval	Yes
Frame Colors	White, Desert Sand, Brz/Wht
Configurations	OX OR XO, OXO, OXXO

FEATURES & BENEFITS

VINYL

- Fusion Welded Structurally Reinforced Vents
- Multi Chambered Frame with Double Weather Stripping – Provides strength, energy efficiency, and maximum air tightness
- Rugged Aluminum Sill Cover
- Dual Mortise Lock with Anti-Slam Device
- Dual Tandem Rollers with Precision ground bearings - adjustable dual cams on lock Weep holes in track - 2 point locking system
- Snap on Covers – to conceal fastener installation
- Anti Lift Panel Devices
- Other Extra Items Available
- Lifetime Warranty on all vinyl frames
- Made in the USA Certified

ALUMINUM-6000

Maximum Size	160 x 80
AAMA/NWWDA170	101A.S.2 - A440
Muntin	Flat
Grid Options	Colonial, Prairie, Perimeter
Product Rating	Bypass +/- 80 PSF
Product Rating	Pocket +/- 80 PSF
HVHZ Approval	Bypass - Yes
HVHZ Approval	Pocket - No
Frame Colors	White & Bronze

ALUMINUM-8100

Maximum Size	32" x 10", 40' x 9'
AAMA/NWWDA170	101A.S.2 - A440
ASTM	1886-1996 MD201202203
Glass Thickness	7/16 HS, 1/2 HS
Muntin	Flat
Grid Options	Colonial, Prairie, Perimeter
Product Rating	C110
HVHZ Approval	Yes
Frame Colors	White & Bronze

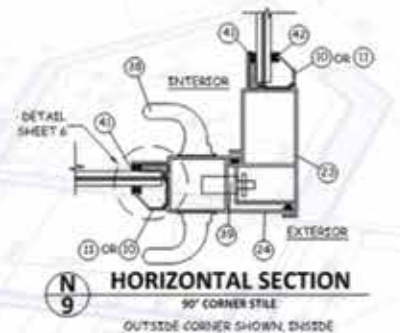

ALUMINUM

- Dual Mortise Lock w/ Anti-Slam Device
- Dual Tandem Rollers – with precision ground bearings
- Adjustable Dual Cams on Locks
- 2-Point Locking System
- Anodized Track Pan w/ Snap on Cover
- Snap on Jamb Covers
- 4" Sill on Panel
- Other Extra Items Available

FRENCH DOOR - Aluminum

Impact & Impact Insulated • Approved for the HVHZ!



SPECIFICATIONS

Maximum Size	72" x 96" - for double doors 36" x 96" - for single doors
Design Pressure	±100 for 3' x 8' w/sil riser ±75 for 6' x 8' w/sil riser
Glass	7/16" Impact 1" Overall Impact Insulated
Muntin	Flat or Grids on insulated units
Grid Options	Colonial, Prairie, Perimeter
Frame Depth	4 3/4"
Colors	White & Bronze
Testing	TAS 20 ¹ , 20 ² , 20 ³ ASTM E 1886 - 1996 AAMA/WDMA/CSA 1011.S/A440
HVHZ Approval	Yes

EXTRA ITEMS

- **1½" Sill Riser** - add on to obtain a higher design pressure.
- **Stainless Steel Components**
- **Insulated Glass**

STANDARD ITEMS

- **Heavy Duty** - engages throw bolts in head and sill and heavy lock in center, all done right from the handle.
- **ADA Sill** - for low clearance.

FEATURES & BENEFITS

- **Unique Cove Mold Design** offers a more traditional wood window exterior appearance.
- **Heavy Walled Construction** – extra heavy duty for real strength.
- **Multi-Point Lock** – featuring a double throw bolt design for maximized locking integrity.
- **Locking Hardware by Interlock** – high quality.
- **Double Veined Felts** – for quiet operation.
- **High mil rubber weather stripping** – used for tighter seal.
- **Stainless Steel Components** – are a great option to utilize for Coastal applications.
- **Insulated Glass** – will help provide energy efficiency to help cut down on electric consumption.



AWNING TYPE - Vinyl

Impact Insulated • Approved for the HVHZ!



SPECIFICATIONS

Maximum Size	5 ³ / ₈ " x 39"
Design Pressure	+65/-70
Design Pressure	+/- 80 up to +100/-120
Glass	Insulated Impact
Muntin	GBG & SDL
Grid Options	Colonial, Prairie, Perimeter
Frame Depth	3 ¹ / ₄ "
Colors	White, Desert Sand & Bronze Ext/White Int
HVHZ Approval	Yes

FEATURES & BENEFITS

- **Fusion Welded 3 1/4" Frame & Sash** provides an impenetrable barrier to air & water penetration and the utmost in strength, stability, and rigidity.
- **Unique Cove Mold Design** offers a more traditional wood window exterior appearance.
- **Heavy Walled Construction** .070" walls are a full 12% thicker than most other windows and provide a better thermal barrier.
- **Perfect Choice** - for cost efficient retrofits.
- **Lifetime Warranty** on all frames and glass.
- **Made in the USA** Certified.

WINDOW MULLIONS - HVHZ Approved

Can be used with any approved product!

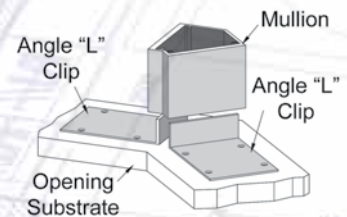
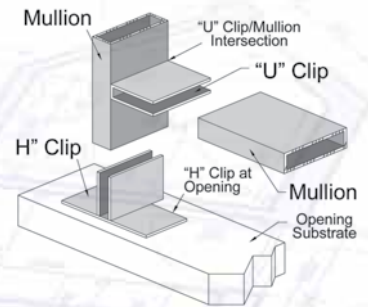
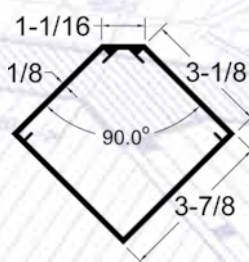
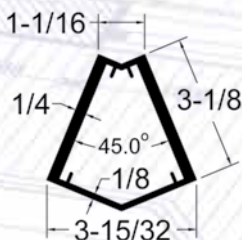
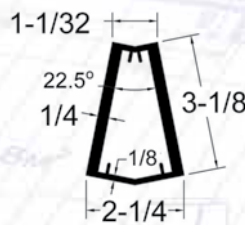
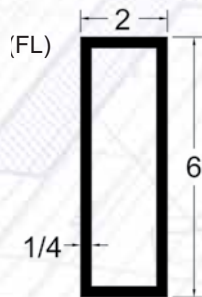
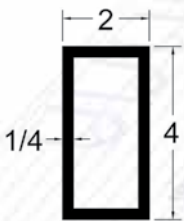
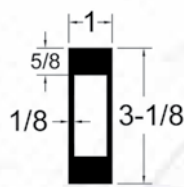
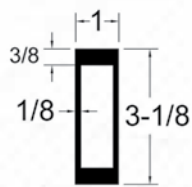

See Approvals FL1605, FL17472 HVHZ and FL 16051 Non-HVHZ for more details.

THE RIGHT PRODUCT AT THE RIGHT PRICE!

Bertha™ Impact Windows & Doors – Engineered to take on Mother Nature

When it comes to choosing the right window product to protect your home and family, Eastern Architectural Systems has it all.

We feature high-quality products that provide a wide range of solutions. Make your home look beautiful and energy efficient at the same time! You and your family deserve the peace-of-mind that EAS windows provide with impact resistant glass that gives you hurricane protection and security 24 hours a day. Yes, our products perform at the highest level!

Eastern Architectural Systems and the Bertha™ line of Impact Windows & Doors, promise to provide you with the most innovative and progressive products available today.



It's no wonder that many of our products have the "Good Housekeeping" seal of approval. We offer Energy Efficiency at its best with our Earthwise™ Vinyl Windows that feature insulated glass and Energy Star ratings. Don't forget that only EAS has the "Made in USA" Certification. Tested and approved to meet the most stringent Building Codes in the USA, including approvals for the High Velocity Hurricane Zone!

Our Team of more than 400 employees will continue to develop and refine our products with the same quality and customer service you have come to expect from Eastern Metal Supply for over 30 years.

All manufactured at our technologically advanced facility in Ft. Myers, Florida. We have an extensive Dealer network that can provide you with a complete & unique package so compelling, it will make you wonder why you waited so long! Can you imagine having a window system that can actually pay for itself? Contact one of our Dealers now, so you can receive code-compliant installations that will help you save on your insurance policy too.



This and so much more from the new industry leader. Call NOW to see how **Eastern Architectural Systems** and **Bertha™ Impact Windows & Doors** can make a difference for your family, your home and your budget (1-800-686-8902)!

*quality,
reliability,
integrity*



Your View is Our Focus.

1-800-686-8902 • www.easternarchitectural.com

Eastern Architectural Systems: 16341 Domestic Avenue, Fort Myers, FL 33912

